

**“AND TAILER MADE NOZZLES”**

# Opbouw bestelcode spuitmondjes

...P  
premium

...S  
standard

...R  
economy

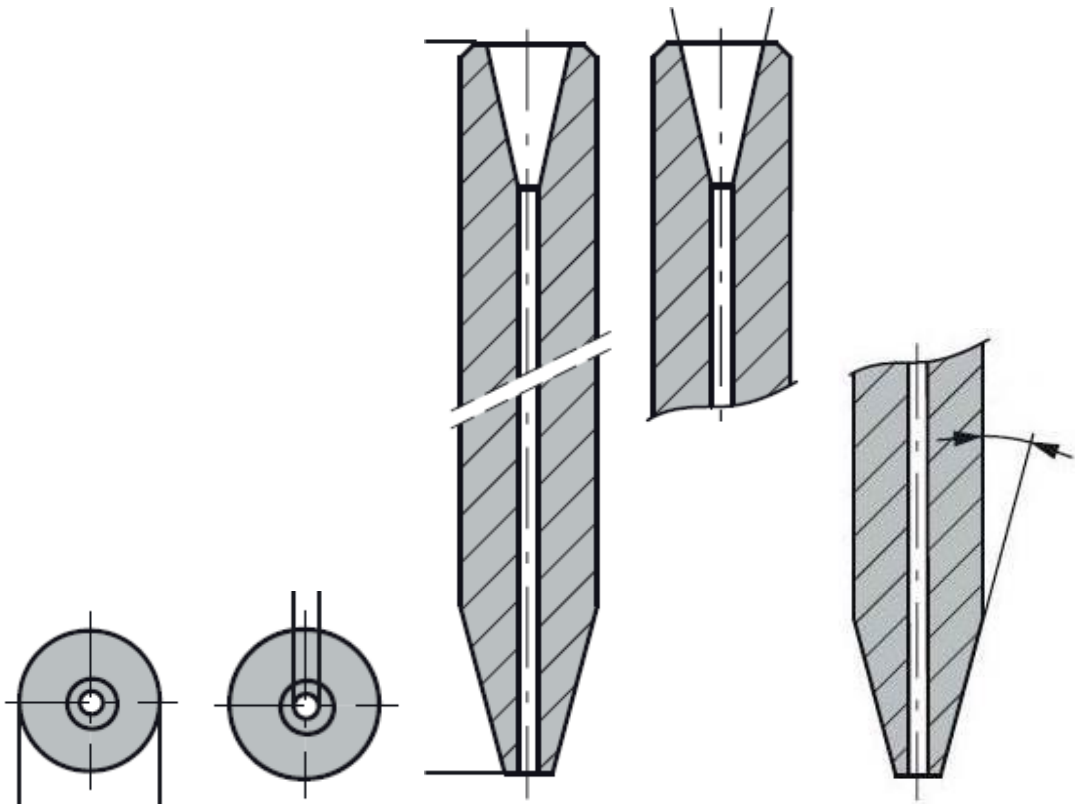

WJNS 0714 - 102 - 0762 - 25 - 15R UMG01

|      |                    |                    |                  |                    |                  |                    |
|------|--------------------|--------------------|------------------|--------------------|------------------|--------------------|
| Type | Diameter<br>buiten | Diameter<br>binnen | Lengte<br>totaal | Invoer ∠<br>binnen | Fase ∠<br>buiten | Materiaal<br>soort |
|------|--------------------|--------------------|------------------|--------------------|------------------|--------------------|

Type WJNR - geslepen buiten en gesinterd binnen / hardmetaalsoort UMG01

Type WJNS - buiten en binnen geslepen / hardmetaalsoort UMG01

Type WJNP - buiten en binnen geslepen / hardmetaalsoort CTN01L

Getallen voor diameters

- 0714 = 7.14 in mm

- 102 = 1.02 in mm

lengtes

- 0762 = 76.2 in mm

Getallen voor hoeken

- 25 = in graden binnen diameter

- 15 = in graden buiten diameter

## Mini Jet Standard Series :



Ø d  
0.50

∠ ID  
30°

...S  
standard

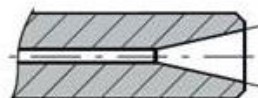
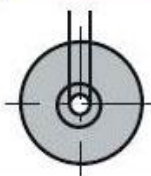

HM  
soort

**WJNS 0799 050 0572 30 25 UMG01**

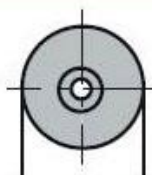

Ø D  
7.99



L  
57.2



∠ OD  
25°

**Aantal            4   st.      10 st.      20 st.      40 st.**

**Prijs/stuk        € 75      € 69      € 65      € 60**

**Netto totaal    € 300    € 690    € 1300    € 2400**

**Mini Jet Premium Series :**



**Ø d**  
**0.50**

**∠ ID**  
**30°**

**...P**  
**premium**

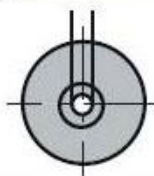

**HM**  
**soort**

**WJNP 0799 050 0572 30 25 CTN01L**

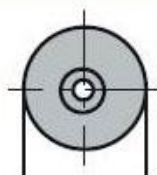

**Ø D**  
**6.35**



**L**  
**76.2**



**∠ OD**  
**15°**

**Aantal            4   st.        10 st.        20 st.        40 st.**

**Prijs/stuk        € 105        € 95        € 90        € 86**

**Netto totaal     € 420        € 950        € 1800        € 3440**



## Mini Jet Tailer Made S series :



$\varnothing d$   
 $\leq 0.76$  en  $\geq 0.50$

$\angle ID$   
 $25^\circ - 40^\circ$

...S  
 standard

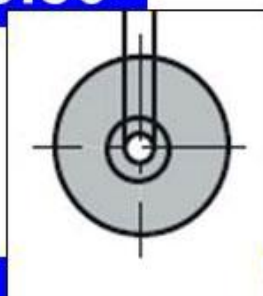

HM  
 soort

WJNS

....

...

....

..

..

UMG01

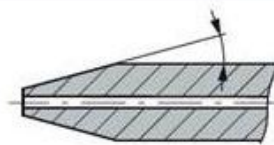
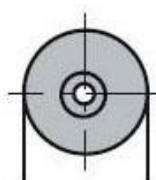

$\varnothing D$   
 $6.00 - 9.43$

L  
 $70.0 - 101.6$

$\angle OD$   
 $15^\circ - 25^\circ$

| Aantal       | 10 st. | 20 st. | 40 st. |
|--------------|--------|--------|--------|
| Prijs/stuk   | € 75   | € 69   | € 65   |
| Netto totaal | € 750  | € 1380 | € 2600 |

Levertijd eerste opdracht 10 weken - daarna uit voorraad NLD

## Mini Jet Tailer Made P series :



$\varnothing d$   
 $\leq 0.76$  en  $\geq 0.50$

$\angle ID$   
 $25^\circ - 40^\circ$

...P  
 premium

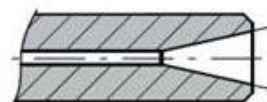
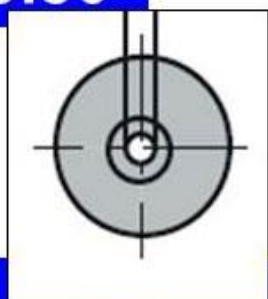

HM  
 soort

WJNP

....

...

....

..

..

CTN01L

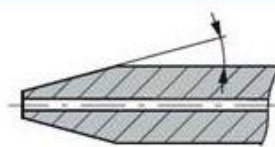
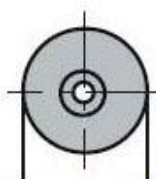

$\varnothing D$   
 $6.00 - 9.43$

L  
 $70.0 - 101.6$

$\angle OD$   
 $15^\circ - 25^\circ$

| Aantal       | 10 st. | 20 st. | 40 st. |
|--------------|--------|--------|--------|
| Prijs/stuk   | € 95   | € 90   | € 86   |
| Netto totaal | € 950  | € 1800 | € 3440 |

Levertijd eerste opdracht 10 weken - daarna uit voorraad NLD

# Big amounts Standard Series 1 :



**Ø d**  
**0.76 - 1.02**

**∠ ID**  
**25°**

**...SS**  
standard

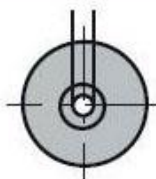

**HM**  
soort

**WJNSS** .... ... .... .. .. **AMW01**

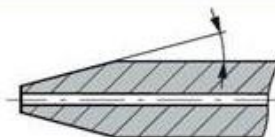
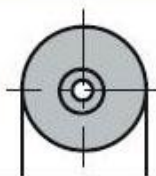

**Ø D**  
**6.00 - 6.70**

**L**  
**70.0 - 76.2**

**∠ OD**  
**15°**

|                     |               |                |                |
|---------------------|---------------|----------------|----------------|
| <b>Aantal</b>       | <b>80 st.</b> | <b>120 st.</b> | <b>200 st.</b> |
| <b>Prijs/stuk</b>   | <b>€ 50</b>   | <b>€ 45</b>    | <b>€ 40</b>    |
| <b>Netto totaal</b> | <b>€ 4000</b> | <b>€ 5400</b>  | <b>€ 8000</b>  |

Levertijd eerste opdracht 6 tot 8 weken - daarna uit voorraad NLD  
 Voorwaarde : 50% bij opdracht + 30% bij aflevering + 20% na 30 dagen

Big amounts Standard Series 2 :



**Ø d**  
**0.76 - 1.09**

**∠ ID**  
**25°**

...SS  
standard

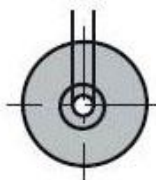

HM  
soort

**WJNSS** .... ... .... .. .. **AMW01**

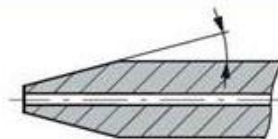
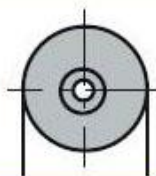

**Ø D**  
**7.14 - 6.72**

**L**  
**76.2 - 79.0**

**∠ OD**  
**15°**

**Aantal**            **80 st.**            **120 st.**            **200 st.**

**Prijs/stuk**        **€ 52**            **€ 47**            **€ 42**

**Netto totaal**    **€ 4160**        **€ 5640**        **€ 8400**

Levertijd eerste opdracht 6 tot 8 weken - daarna uit voorraad NLD  
Voorwaarde : 50% bij opdracht + 30% bij aflevering + 20% na 30 dagen



## Big amounts Standard Series 3 :



$\varnothing d$   
0.76 - 1.02

$\angle ID$   
25°

...SS  
standard

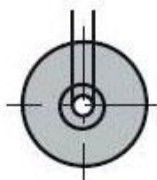

HM  
soort

WJNSS

....

...

....

..

..

AMW01

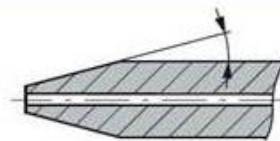
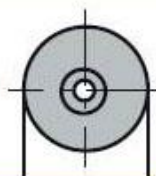

$\varnothing D$   
7.97 - 9.43

L  
76.2

$\angle OD$   
15°

|              |        |         |         |
|--------------|--------|---------|---------|
| Aantal       | 80 st. | 120 st. | 200 st. |
| Prijs/stuk   | € 57   | € 52    | € 47    |
| Netto totaal | € 4560 | € 6240  | € 9400  |

Levertijd eerste opdracht 6 tot 8 weken - daarna uit voorraad NLD  
Voorwaarde : 50% bij opdracht + 30% bij aflevering + 20% na 30 dagen

